

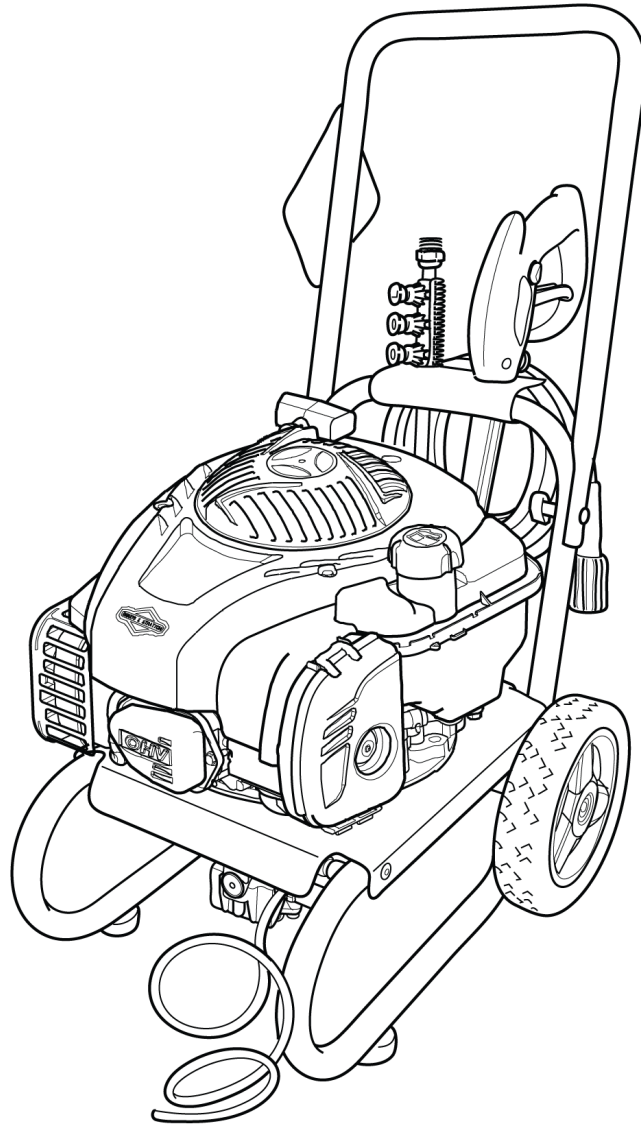

Parts Manual

Mfg. No: 020635-00
2,200 PSI Briggs & Stratton



Model Components	Page
Main Unit (80014632).....	4
Pump (80008354).....	6
Torque Specification Chart.....	7

Not For
Reproduction

Main Unit (80014632)

Note: Unless noted otherwise, use the standard torque specifications

Mfg. No: 020635-00

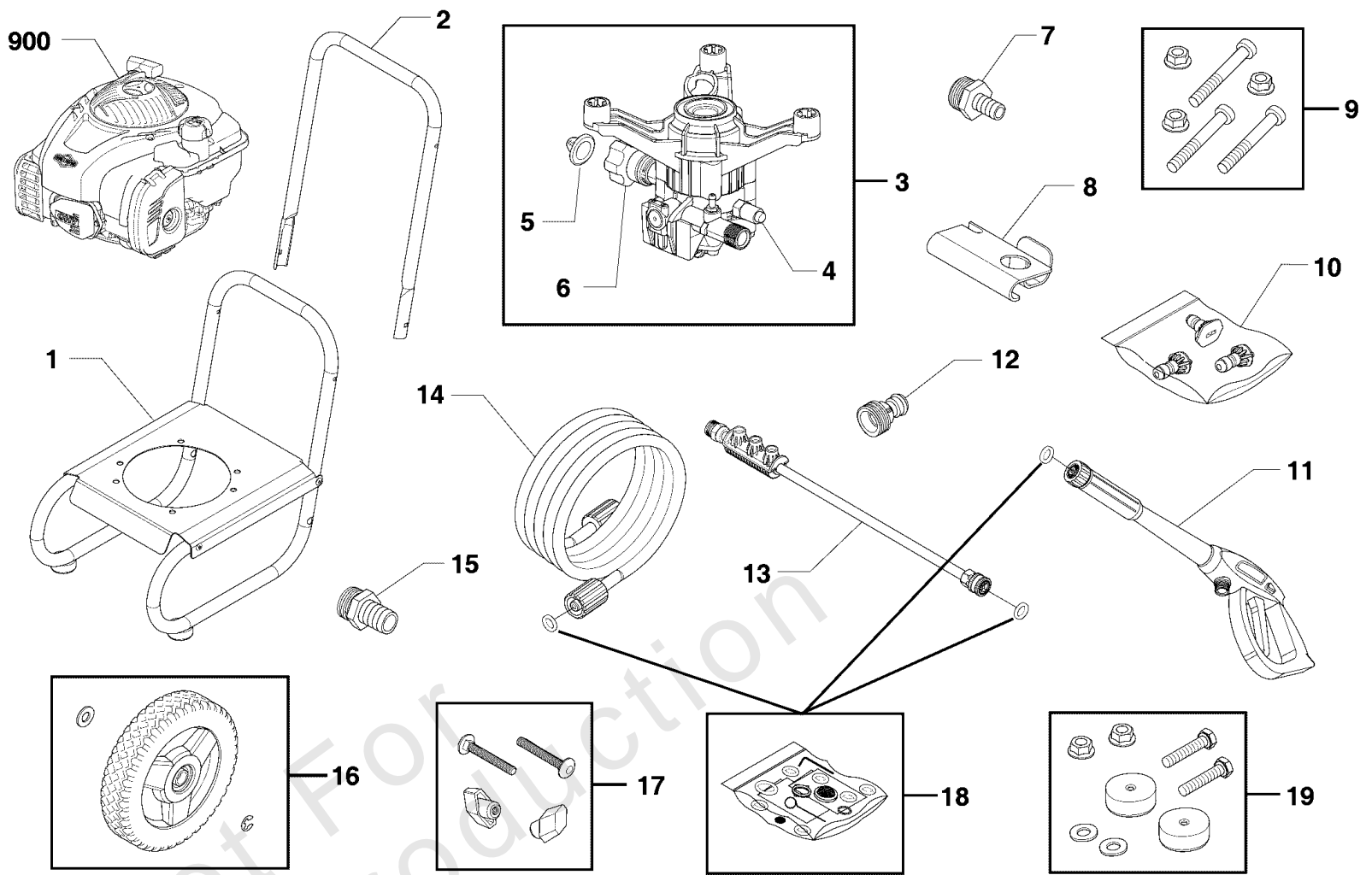

Main Unit (80014632)

REF NO	PART NO	QTY	DESCRIPTION
1	707770		BASE
2	206781BJGS		HANDLE
3	705274		PUMP
4	318923GS		VALVE, Thermal Relief
5	B2384GS		FILTER, Garden Hose
6	319490GS		ADAPTER, Garden Hose
7	192014GS		FITTING, 1/2
8	206813GS		HOLDER, Accessory
--	B1797GS		CLIP
9	315033GS		KIT, Hardware, Pump Mounting
10	314080GS		KIT, QC Nozzles
--	198841GS		NOZZLE, QC, Black
--	195983AEGS		NOZZLE, QC, Red
--	195983AGGS		NOZZLE, QC, Green
11	708807		GUN, BIT
12	95456GS		QUICK CONNECT
13	207790GS		WAND, Nozzle Holder
14	708962		HOSE
15	192015GS		FITTING, 3/4
16	208619GS		KIT, Wheel
--	192050GS		E-RING, Axle, 1/2
17	B2203GS		KIT, Hardware, Handle
18	705001		KIT-O-RING
19	192310GS		KIT, Vibration Mount
900	09P702-0176-H1		**ENGINE
--	705076		HOSE-CHEMICAL -(Not Illustrated)
--	312876GS		AXLE -(Not Illustrated)
--	23139GS		KEY -(Not Illustrated)
--	706602		TAG-HANG, WARNING -(Not Illustrated)
--	6039		PUMP Saver -(Not Illustrated)
--	6059		PERFECT MIX MULTI-PURPOSE WASH -(Not Illustrated)
--	6160		Project Pro® PerfectMix Concrete, Brick, And Tile Cleaner -(Not Illustrated)

Footnotes:

(Optional Accessory - Not Included)

(** Note: Verify your specific engine model, reference the ID Tag located on your engine. Refer to your local Briggs & Stratton distributor for parts and service.)

Pump (80008354)

REF NO	PART NO	QTY	DESCRIPTION
--	-----		REFERENCE MAIN UNIT EXP VIEWS

Not For
Reproduction

Footnotes:
(Pump Being Serviced Complete)

Hardware Identification & Torque Specifications

Torque Specification Chart								
FOR STANDARD METRIC MACHINE HARDWARE (Tolerance ± 20%)								
Property Class	5.6		8.8		10.9		12.9	
	Class 5.6		Class 8.8		Class 10.9		Class 12.9	
Size Of Hardware	in/lbs	Nm.	in/lbs	Nm.	in/lbs	Nm.	in/lbs	Nm.
	ft/lbs		ft/lbs		ft/lbs		ft/lbs	
M3	5.88	.56	13.44	1.28	19.2	1.80	22.92	2.15
M4	13.44	1.28	30.72	2.90	43.44	4.10	52.56	4.95
M5	26.4	2.50	60.96	5.75	5.97	8.10	7.15	9.7
M6	44.64	4.3	7.3	9.9	10.3	14	12.1	16.5
M7	5.2	7.1	12.1	16.5	16.9	23	19.9	27
M8	7.7	10.5	17.7	24	25	34	29	40
M10	15	21	35	48	50	67	59	81
M12	26	36	61	83	86.2	117	103	140
M14	42	58	101	132	136	185	162	220
M16	64	88	147	200	210	285	250	340
M18	89	121	202	275	287	390	346	470
M20	126	171	290	390	405	550	486	660
M22	169	230	390	530	559	745	656	890
M24	217	295	497	375	708	960	840	1140
M27	320	435	733	995	1032	1400	1239	1680
M30	435	590	995	1350	1401	1900	1681	2280
M33	590	800	1349	1830	1902	2580	2278	3090
M36	759	1030	1740	2360	2441	3310	2935	3980
M39	988	1340	2249	3050	3163	4290	3798	5150

Torque Specification Chart						
FOR STANDARD MACHINE HARDWARE (Tolerance ± 20%)						
Hardware Grade	No Marks		SAE Grade 5		SAE Grade 8	
	SAE Grade 2		SAE Grade 5		SAE Grade 8	
Size Of Hardware	in/lbs	Nm.	in/lbs	Nm.	in/lbs	Nm.
	ft/lbs		ft/lbs		ft/lbs	
8-32	19	2.1	30	3.4	41	4.6
8-36	20	2.3	31	3.5	43	4.9
10-24	27	3.1	43	4.9	60	6.8
10-32	31	3.5	49	5.5	68	7.7
1/4-20	66	7.6	8	10.9	12	16.3
1/4-28	76	8.6	10	13.6	14	19.0
5/16-18	11	15.0	17	23.1	25	34.0
5/16-24	12	16.3	19	25.8	29	34.0
3/8-16	20	27.2	30	40.8	45	61.2
3/8-24	23	31.3	35	47.6	50	68.0
7/16-14	30	40.8	50	68.0	70	95.2
7/16-20	35	47.6	55	74.8	80	108.8
1/2-13	50	68.0	75	102.0	110	149.6
1/2-20	55	74.8	90	122.4	120	163.2
9/16-12	65	88.4	110	149.6	150	204.0
9/16-18	75	102.0	120	163.2	170	231.2
5/8-11	90	122.4	150	204.0	220	299.2
5/8-18	100	136	180	244.8	240	326.4
3/4-10	160	217.6	260	353.6	386	525.0
3/4-16	180	244.8	300	408.0	420	571.2
7/8-9	140	190.4	400	544.0	600	816.0
7/8-14	155	210.8	440	598.4	660	897.6
1-8	220	299.2	580	788.8	900	1,244.0
1-12	240	326.4	640	870.4	1,000	1,360.0

The guides and ruler furnished below are designed to help you select the appropriate hardware.



Nut, M8

Thread Diameter (mm)

Inside Diameter (in) Threads per inch

Nut, 1/2-16

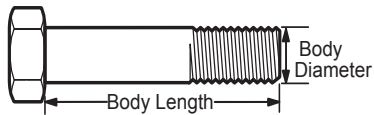

Screw, M8- 1.25 x 25

Thread Diameter (mm) Distance between threads (mm) Body Length (mm)

Body Diameter Threads per inch Body Length (in)

Screw, 1/2- 16 x 2

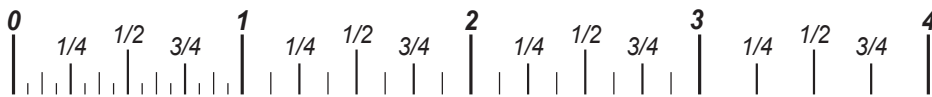

Standard Hardware Sizing

When a washer or nut is identified as 1/2" (M8), this is the *Nominal size*, meaning the *inside diameter* is 1/2 inch (8mm metric thread diameter); if a second number is present it represents the *threads per inch* (distance between threads).

When bolt or capscrew is identified as 1/2 - 16 x 2" (M8 - 1.25 x 50), this means the *Nominal size*, or body diameter is 1/2 inch (8mm metric thread diameter), the second number, 16, represents the *threads per inch*, (*distance between threads*). The final number is the body length of the bolt or screw, 2 inches (50mm).

NOTES

- These torque values are to be used for all hardware excluding: locknuts, self-tapping screws, thread forming screws, sheet metal screws and socket head setscrews.
- Recommended seating torque values for locknuts:
 - for prevailing torque locknuts - use 65% of grade 5 torques.
 - for flange whizlock nuts and screws - use 135% of grade 5 torques.
- Unless otherwise noted on assembly drawings, all torque values must meet this specification.

Common Hardware Types

Hex Head Capscrew

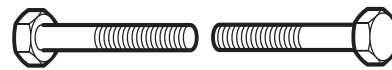

Washer

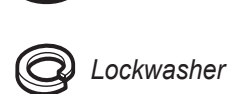

Carriage Bolt

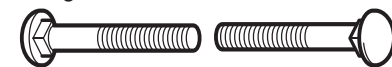

Hex Nut

Wrench & Fastener Size Guide

1/4" Bolt or Nut Wrench—7/16"	5/16" Bolt or Nut Wrench—1/2"	3/8" Bolt or Nut Wrench—9/16"	7/16" Bolt or Nut Wrench (Bolt)—5/8" Wrench (Nut)—11/16"	1/2" Bolt or Nut Wrench—3/4"
M6 Bolt or Nut Wrench—10mm	M8 Bolt or Nut Wrench—13mm	M10 Bolt or Nut Wrench—17mm	M12 Bolt or Nut Wrench—19mm	M14 Bolt or Nut Wrench—22mm

